

Sweeping machines FS 100-120

FS100-120 B/D sweeping machines



Concept

FS 100/120

have been designed to offer:

- maximum driving comfort to the operator and best accessibility for ordinary maintenance operations
- reduced absorption with longer operating autonomy
- maximum reliability and best machine accessibility

FS 100/120

**Improve operators'
quality of work!**

THE BENEFITS

Improved operators' quality of work!



The driver's seat has been designed to suit the operator and to make his/her job as comfortable as possible. Steering wheel, back and armrest with adjustable inclination.

THE BENEFITS

Improved operators' quality of work!

The four main control levers are positioned to make driving as easy as possible.

The four levers are:

1. lever to operate and lower the main brush and to start suction automatically. Depending on requirements, suction can be switched off.
2. lever to start the side brush.
3. lever to open and close the lid of the dirt hopper.
4. lever to lift the dirt hopper

The levers operate the slide valve directly without any electrical connection.



THE BENEFITS

Improved operators' quality of work!



COMFORT

The drive pedal
is servo assisted
for extremely smooth
and precise operation

THE BENEFITS

Improved operators' quality of work!

COMFORT

A convenient step helps the operator to get to the driver's seat



FS 100/120

**Excellent accessibility for
ordinary and extraordinary
maintenance procedures!**

THE BENEFITS

Excellent accessibility for ordinary and extraordinary maintenance procedures

**The FS 100/120
sweeping machines**
have been designed to provide
Best accessibility to the
motor compartment.

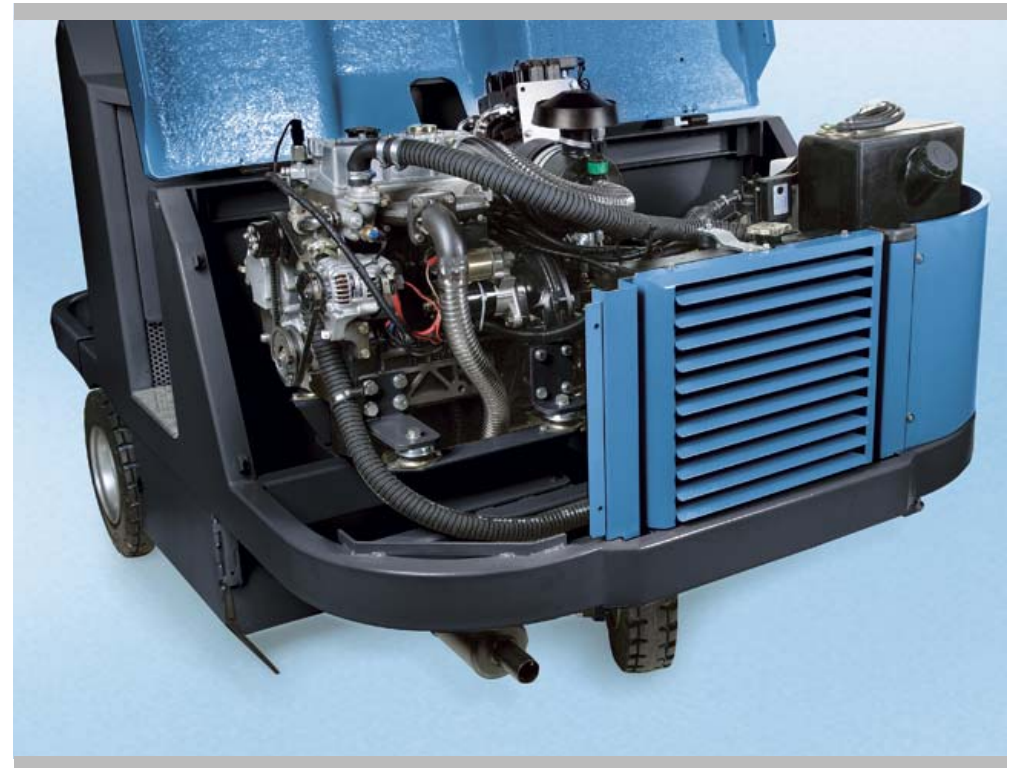

THE BENEFITS

Excellent accessibility for ordinary and extraordinary maintenance procedures

Thanks to the accurate design, all ordinary and extraordinary Maintenance operations can be easily performed on the machine without any hindrance even when the protective roof is fitted



THE BENEFITS

Excellent accessibility for ordinary and extraordinary maintenance procedures

Oil level control and filter change,
for instance on the motor-Diesel version,
have become
extremely simple

THE BENEFITS

Excellent accessibility for ordinary and extraordinary maintenance procedures



The fabric pocket filter, with its filtering surface of more than 11 m² (120 version) ensures long life and excellent results event in environments With high levels of fine dust. The filter can be easily removed for cleaning without requiring any tools

THE BENEFITS

Large capacity of the dirt hopper

The dirt hopper on the front, with its capacity of 570* l (FS100), 600* l (FS120), is lifted by a dual-piston hydraulic system that is easily operated from the driver's seat and can reach 1,5 m dumping height.

* Total capacity



I VANTAGGI

Reduced Absorption

As a consequence,
the operating autonomy of the battery-powered version
is increased up to 5 hours
which makes it competitive
on large size areas versus the Diesel version

On the Diesel version,
consumption and emissions are reduced

THE BENEFITS

Excellent cleaning results



- Much stronger tubular frame
- **Traction**, with rear drive wheel, ensures excellent manoeuvrability and safety as well as a very tight turning radius
- Double filtering system of the hydraulic circuit
- Hydraulic oil cooler to keep temperature under control also in warm climate regions
- Different hydraulic circuits depending on required pressure

THE BENEFITS

Excellent cleaning results

The main brush is floating
and self-adjusting to maintain
constant contact with the floor.
The side brushes is retractable
to absorb accidental impacts
and prevent any possible damage
Both brushes can be easily removed
for replacement
and the main one, in particular,
does not require any tools at all



THE BENEFITS

Excellent cleaning results

**Suction is powered
by a hydraulic motor
to ensure top performance
and best reliability over time**

**On request,
the double-brush version
is also available**







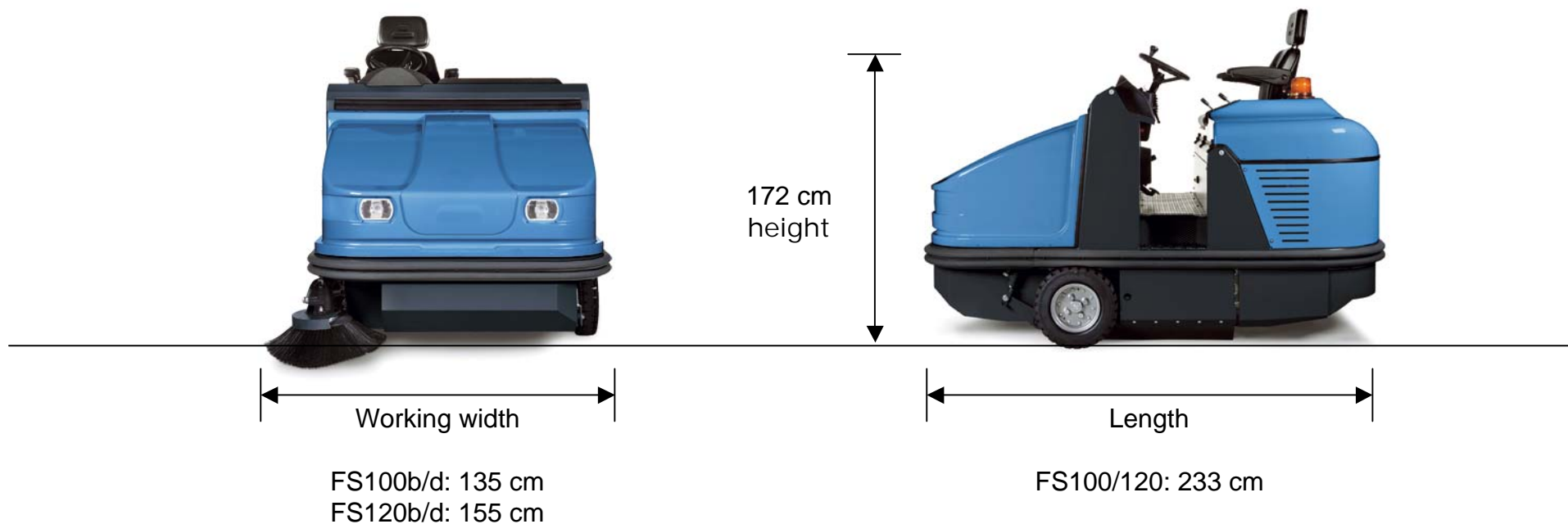







All the numbers of **FS 100/120**

All the numbers of **FS 100/120**



All the numbers: FS 100/120

FIMA P	 Working width (with side brush)	 Number of side brushes/ Ø mm	 Power supply V/ traction	 Central brush width	 Front-mounted hopper	 Rear-mounted hopper	 Type of dumping system	 Working width up to m ² /h	 Machine dimensions mm L x H x W	 Machine weight kg (without batteries)
FS100 B FS120 B 	1350 1550	1/500	36/Hydraulic	1000 1200	•	-	Hydraulic	9.450 10.850	2330-x1720-x1380 2330-x1720-x1510	960 990
FS100 D FS120 D 	1350 1550	1/500	-/Hydraulic	1000 1200	•	-	Hydraulic	11.475 13.175	2330-x1720-x1380 2330-x1720-x1510	1070 1100
FS100 GPL FS120 GPL 	1350 1550	1/500	-/Hydraulic	1000 1200	•	-	Hydraulic	11.475 13.175	2330-x1720-x1380 2330-x1720-x1510	1070 1100

All the numbers: FS 100/120

TECHNICAL DESCRIPTION		FS100 B	FS100D	FS100GP L	FS120B	FS120D	FS120D
Forward speed	km/h	0÷7	0÷8,5	0÷8,5	0÷7	0÷8,5	0÷8,5
Max gradient with empty hopper	%	10	15	15	10	15	15
Electric motor	V/W	36/6000	-	-	36/6000	-	-
Diesel Motor PERKINS 403D-11	HP	-	28/17,3	-	-	28/17,3	-
Gasolina/GPL Motor KUBOTA DF 972	HP	-	-	28/17,5	-	-	28/17,5
Filter shaker motor	V/W	12/110	12/110	12/110	12/110	12/110	12/110
Suction motor	mc/h	Idraulico 250	Idraulico 250	Idraulico 250	Idraulico 250	Idraulico 250	Idraulico 250
Dumping height	mm	1500	1500	1500	1500	1500	1500
Debris hopper capacity (Total)	l	570	570	570	600	600	600
Debris hopper capacity (Capacità without filter)	l	400	400	400	420	420	420
Filter surface ara (Pocket filter)	m ²	10	10	10	11	11	11
Batteries	V/A	36/640	-	-	36/640	-	-
Battery weight	kg	720	-	-	720	-	-

Ownership of the information and/or documents:

All information (by which we mean all data and information with the sole exception of that of common knowledge or which FIMAP has disclosed without reserve) and all documents (drawings, photos, etc.) are the exclusive property of FIMAP and their use does not mean there is any kind of acquisition of titles, property or exploitation of rights or licences except for the limited permission of use ruled by this document.

By way of example and, therefore, not limited to, such information and/or documents can be the following:

Marketing section:

high definition digital images for the implementation of commercial catalogues on paper or web sites, company trademarks, original graphical documents from which texts are taken (e.g. the descriptive notes), PDF documents and original documents in .ppt format.

Professional use of the data:

It is a known fact that the information and/or documents, subject of this commitment, are and will be used by the beneficiary exclusively for carrying out his professional business and, therefore, no specific laws regarding consumer protection are applicable.

Confidentiality:

The Party that benefits from the information or use of documents taken from or, in any case, part of the commercial documentation, shall use all such information and/or documents with maximum care solely for the purposes connected to execution of this contract with FIMAP and shall:

keep such information and/or documents confidential except for those, due to their nature, which are to be disclosed (promo-advertising material etc.);

shall not divulge any information and/or document to its suppliers, collaborators or employees beyond what is strictly necessary so that they may fulfil their tasks concerning relations with FIMAP and shall ensure that the suppliers, collaborators and employees that have access to the information and/or documents are, in turn, bound by a confidentiality commitment to the benefit of FIMAP; shall not divulge any information to third parties without the prior written consent by FIMAP; copy and/or in any other way reproduce any information or document without the prior written consent of FIMAP; take all the necessary measures to protect confidentiality.

Returning Information and/or documents:

Whilst maintaining exclusive ownership at all times, FIMAP has the right, at any time, to ask in writing or by e-mail, that all the information and/or documents received be returned or no longer used and within the term of thirty days from receipt of this request, all the information and/or documents must be returned, including any copies, or destroy such information and/or documents and relative copies so as to prevent them from being recovered and FIMAP must be given a written declaration certifying that the information and/or documents have all either been returned or destroyed.

This obligation to return, destroy or no longer use is set automatically in motion when the relationship is cancelled with FIMAP for any reason whatsoever.

Applicable law, cancelling clauses and Court having jurisdiction:

The interpretation, integration, execution and the effects of this commitment will be governed by Italian law.

If one or more points of this agreement are cancelled it does not invalidate the remaining points.

All disputes will be put to the exclusive jurisdiction of the Verona Courts.